



ELSEVIER

Journal of Nuclear Materials 258–263 (1998) 252–257

**Journal of
nuclear
materials**

Section 2. R&D for next fusion device

Fabrication and high heat flux testing of plasma sprayed beryllium ITER first wall mock-ups

R.G. Castro ^{a,*}, K.E. Elliot ^a, R.D. Watson ^b, D.L. Youchison ^b, K.T. Slattery ^c^a *Los Alamos National Laboratory, MST-6, Material Science and Technology Division, Metallurgy G770, Los Alamos, NM 87545, USA*^b *Sandia National Laboratory, Fusion Technology Department, Albuquerque, NM 87185, USA*^c *High Energy Systems, The Boeing Company, St. Louis, MO 63166, USA*

Abstract

Plasma-sprayed beryllium ITER first wall mock-ups have survived 3000 thermal fatigue cycles at 1 MW/m² without damage during testing at the Plasma Materials Test Facility at Sandia National Laboratory in New Mexico. This heat flux level is twice the expected design heat flux for ITER first wall modules. Plasma sprayed beryllium mock-ups were vacuum plasma sprayed at the Los Alamos National Laboratory's Beryllium Atomization and Thermal Spray Facility. Results will be reported on the fabrication, high heat flux testing and post-mortem analysis of two beryllium plasma sprayed mock-ups (1) beryllium plasma sprayed directly on a CuNiBe heat sink and (2) beryllium plasma sprayed on a compliant layer of aluminum which was explosion-bonded to a CuCrZr copper heat sink. The high heat flux tests utilized the 30 kW Electron Beam Test System at a Sandia National Laboratory. © 1998 Published by Elsevier Science B.V. All rights reserved.

1. Introduction

In order to provide beryllium armor on the first wall of the International Thermonuclear Experimental Reactor ITER a joining method will need to be developed to join the beryllium first wall armor to the underlying copper heat sink. The selected joining method will need to produce highly reliable joints which can survive the thermal heat loads which will be experienced during normal and off-normal operations in ITER. A number of joining techniques are currently being investigated by ITER researchers which include silverless brazing, diffusion bonding, hot isostatic press (HIP) bonding, explosive bonding and plasma spraying [1]. In all cases joining beryllium directly to copper presents a challenging problem due to the formation of brittle intermetallic compounds (e.g. BeCu, Be₂Cu) at the interface. One of the requirements for selecting a joining process will be the ease of joining large flat and curved surfaces

of beryllium directly at copper. Plasma spraying has been identified for both beryllium and tungsten as a potential primary or backup technology for fabricating the armor on the primary and limiter first wall modules (which is approximately 1000 m²) and the wing and gas box liner in the divertor [2]. Plasma spraying is preferred due to the potential for providing thick armor (1–10 mm) coatings of beryllium and tungsten directly on large flat and curved copper surfaces. Research investigations on plasma spraying of beryllium have focused mainly on developing this technology for in situ repair applications of damaged beryllium first wall armor surfaces. High density (>95% of theoretical) and high thermal conductivity (~195 W/m K at room temperature) beryllium coatings with Be to Be bond strengths of approximately 100 MPa have been developed for this application [3,4]. In this investigation two Be/Cu first wall mock-ups were fabricated by vacuum plasma spraying and subsequently high heat flux tested at ITER relevant conditions, to demonstrate the feasibility of using this technology for fabrication of the beryllium first wall structure. The Be/Cu first wall mock-ups were tested at the high heat flux testing facility at Sandia National Laboratory utilizing the 30 kW Electron Beam Test System (EBTS).

* Corresponding author. Tel.: +1-505 667 5191; fax: +1-505 667 5268; e-mail: rcastro@lanl.gov.

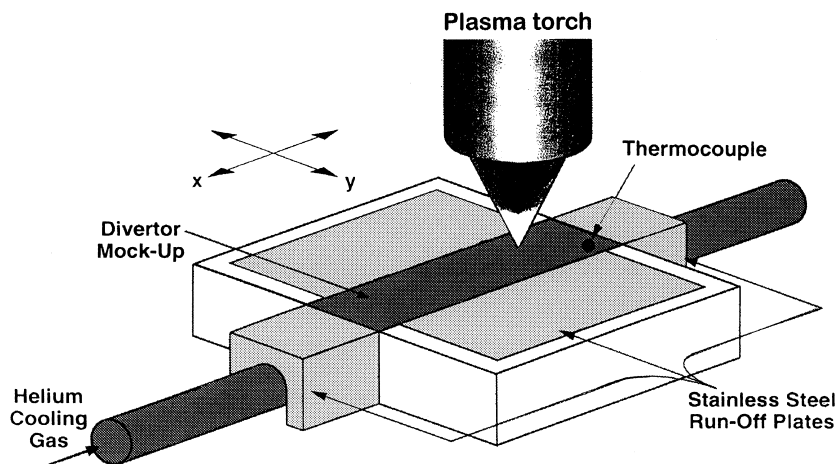

Fig. 1. Schematic illustrating the fabrication of the Be/Cu plasma sprayed mock-up.

2. Experimental

2.1. Fabrication of Be/Cu plasma sprayed mock-ups

Fabrication of the Be/Cu first wall mock-ups was done in the vacuum plasma spray facility at the Los Alamos National Laboratory's Beryllium Atomization and Thermal Spray Facility. Details of this facility are given in Ref. [3]. The beryllium was plasma sprayed on two different copper heat sinks which were provided by High Energy Systems Group of the Boeing Company (formerly McDonnell Douglas Aerospace) for this investigation: (1) CuNiBe (Hycon-3) heat sink and (2) CuCrZr (Elbrodur) heat sink which had 1100 aluminum explosively bonded to the surface with a 1 mm titanium diffusion barrier interlayer between the copper and aluminum. Explosive bonding of the copper to the aluminum was provided by Northwest Technologies. Heat sinks from CuNiBe and the CuCrZr were machined from blocks which had a smooth circular cooling channel. The ends of the block were turned down to a 14 mm tube diameter in order to attach the copper heat sink to the EBTS testing fixture. The beryllium was plasma sprayed on a flat section of the copper heat sink 87 mm long \times 25 mm wide. Prior to plasma spraying, the copper and aluminum surfaces were knurled using electro-discharge machining (EDM) in order to enhance the mechanical bond between the beryllium coating and the substrate. The knurl was 0.076 mm deep with a radius of 0.125 mm. To fabricate the Be/Cu mock-ups a stainless steel fixture was designed to position the copper heat sinks directly under the plasma spray torch, Fig. 1. A thick (>15 mm) uniform beryllium coating was deposited on the 87 mm long \times 25 mm wide surface of the copper heat sink by translating the plasma spray torch in an X and Y motion along the length of the heat sink.

The plasma spray torch was allowed to extend approximately 50 mm from side to side onto stainless run-off plates. The oversprayed material was subsequently used for characterization of the beryllium plasma sprayed deposits after fabrication of the Be/Cu mock-ups. During deposition a helium cooling gas was introduced through the copper heat sink to control the temperature. Cooling of the copper heat sink was done to minimize the formation of brittle intermetallics between the copper and beryllium and to prevent melting of the explosive bonded aluminum layer. Controlling the temperature also minimizes the build-up of thermal stresses during the deposition process. A type K thermocouple was inserted through the backside of the copper heat sink to monitor the temperature. Negative transferred-arc (TA) cleaning was used to preheat and prepare the copper heat sinks prior to depositing beryllium. The CuCrZr heat sink with the explosive bonded aluminum surface layer was preheated to a lower temperature (550°C) than the CuNiBe heat sink in order to prevent melting of the aluminum surface. The operating parameters used for plasma spraying beryllium are given in

Table 1
Operating conditions for plasma spraying beryllium

Parameters	Settings
Plasma torch	SG-100
Primary gas (slm)	40-Ar
Secondary gas (slm)	1-H ₂
Powder gas (slm)	1-Ar
Voltage (V)	40
Current (A)	600
Chamber pressure (MPa)	0.053–0.060
Powder feed rate (g/s)	0.126
Spray distance (mm)	88.9

a. Plasma sprayed Be armor on heat sink

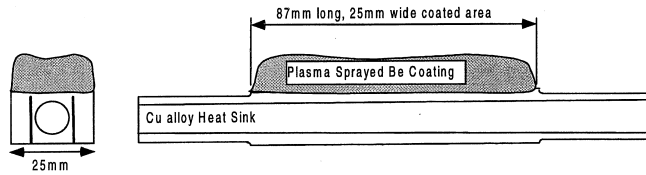

b. Armor and heat sink diagram

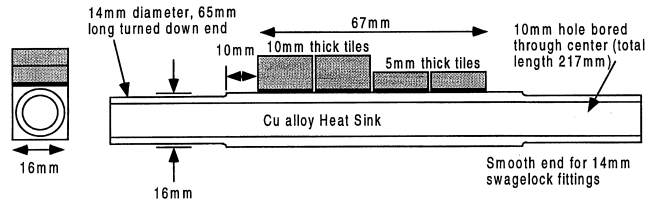

c. Armor thermocouple hole diagram

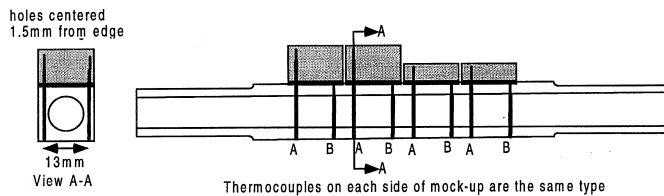

d. Armor sub-castellation diagram

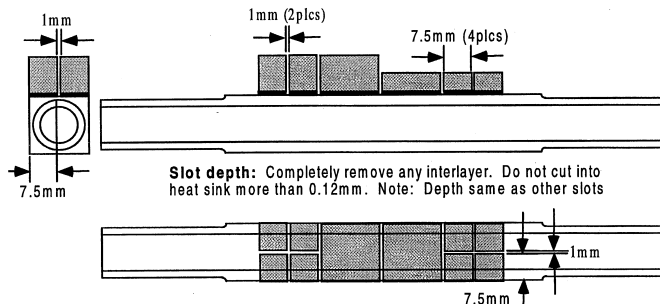

Fig. 2. Illustration of plasma sprayed Be/Cu mock-ups (a) plasma sprayed beryllium armor on heat sink; (b) armor and heat sink diagram; (c) armor thermocouple hole diagram; (d) armor sub-castellation diagram.

Table 1. Spherical inert gas atomized beryllium powder with a size range of -38 to $+10$ μm was the feedstock material used for producing the beryllium armor coatings. A schematic illustrating the beryllium coating plasma sprayed on the copper heat sink is given in Fig. 2(a). The width of the copper heat sink was EDM machined from the initial 25 to 16 mm after depositing the beryllium. Two tile thicknesses (5 and 10 mm) were machined from the plasma sprayed beryllium armor, Fig. 2(b). Sixteen thermocouple holes were drilled into the copper substrate and the 5 and 10 mm beryllium

tiles, Fig. 2(c). Sub-castellation of one 10 and 5 mm tile was done to minimize thermal stress during the high heat flux electron beam test, Fig. 2(d).

2.2. High heat flux testing

High heat flux testing of the Be/Cu mock-ups were performed at the Plasma Materials Test Facility at Sandia National Laboratory using the 30 kW Electron Beam Test System (EBTS). The EBTS is a multi-purpose device for studying the surface modification, thermal

response and failure modes of materials and components exposed to high energy heat loads. Details of the facility are given in Ref. [5]. Thermal fatigue testing of the Be/Cu mock-ups were performed initially at 1 MW/m^2 which is twice the expected peak heat flux for the ITER primary first wall modules (0.5 MW/m^2). Subsequent thermal cycling was performed at 3 and 5 MW/m^2 heat fluxes until the Be/Cu mock-ups failed. Failure of the Be/Cu mockup was indicated by a large increase in the surface temperature of the beryllium armor tiles. Testing at 1 MW/m^2 was done with a water inlet temperature of 160°C , a pressure of 4 MPa and a velocity of 1 m/s. Pulse lengths of 20 s on and 20 s off were sufficient to reach 90% of steady-state temperature profiles within the mock-up.

3. Results and discussion

3.1. Beryllium plasma sprayed Be/Cu mock-ups

A photograph of a copper heat sink and three plasma sprayed Be/Cu mock-ups is given in Fig. 3. The first mock-up is plasma sprayed beryllium on the CuNiBe, the second mock-up is plasma sprayed beryllium on the CuCrZr heat sink with the explosive bonded aluminum layer and the third mock-up was plasma sprayed be-

ryllium on a Cu–Glidcop heat sink which had an interlayer of vanadium plasma sprayed on the surface prior to depositing beryllium. The third mock-up showed extensive layer separation between the beryllium armor and the copper heat sink after machining and was therefore not included in the high heat flux tests. Details of the Cu–Glidcop mock-up will not be discussed in this report. The beryllium armor deposited on the heat sinks was approximately 6 cm wide \times 8 cm long. The coating was approximately 18 mm thick. Approximately 2 cm of the beryllium plasma sprayed armor hung over the sides of the copper mock-up. This resulted from the deposition of beryllium on the stainless steel run-off plates during the *X* and *Y* translation of the plasma torch over the copper heat sink. The stainless steel run-off plates were easily separated from the beryllium coating following the deposition process. Translation of the plasma spray torch over the heat sinks resulted in a uniform build-up of the beryllium armor. Some edge lifting of the beryllium armor was observed at the end of each mock-up after it cooled to room temperature. The CuCrZr heat sink which had the explosive bonded aluminum layer showed a smaller amount of edge lifting (approximately 1 mm separation) when compared to the beryllium sprayed directly on the CuNiBe which showed approximately 2–3 mm of separation. The edge lifting was eliminated during the profiling and machining of the

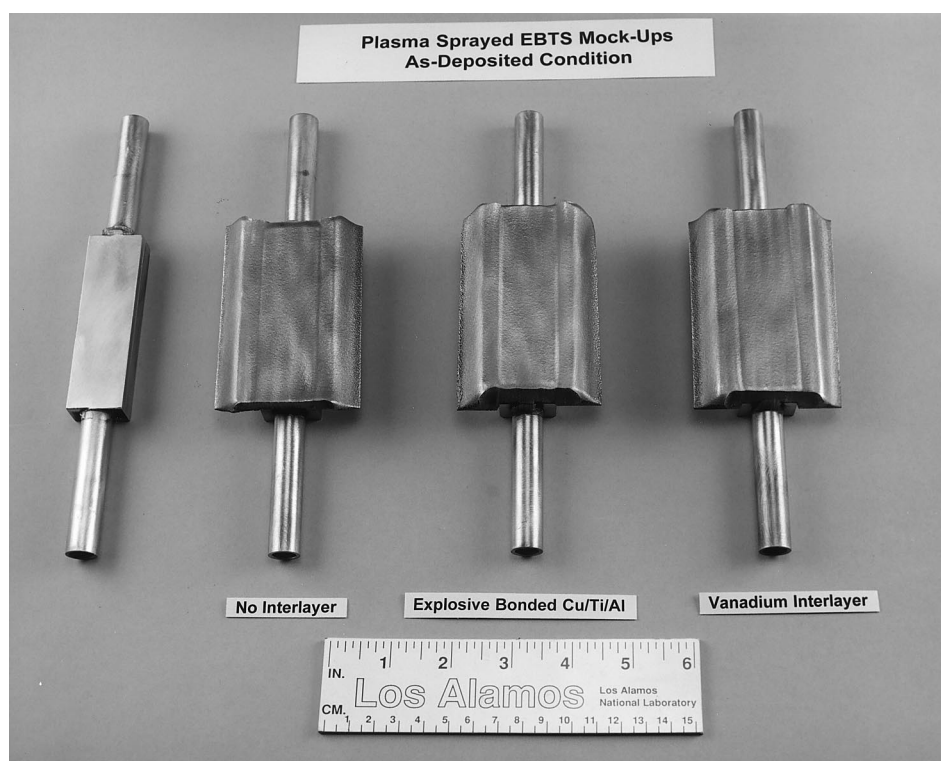

Fig. 3. Photograph of plasma sprayed beryllium armor on copper heat sinks.

5 and 10 mm beryllium armor tiles. Ultrasonic inspection of the Be/Cu mock-ups was performed prior to the high flux testing and showed no evidence of any layer separation between the beryllium armor and the heat sink material.

3.2. High heat flux testing results: CuNiBe mock-up

The Be/Cu mock-up fabricated from the CuNiBe heat sink was tested at 1 MW/m^2 for 3000 cycles on all four of the individual beryllium 5 and 10 mm tiles with no damage except for a discoloration of the surface and a slight increase in the surface temperature of one of the sub-castellated section. The temperature of the interface between the beryllium armor and the CuNiBe heat sink was typically 240°C . The peak surface temperatures of the beryllium tiles remained below 550°C during the 3000 thermal fatigue cycles. After completing the thermal cycles at 1 MW/m^2 , the tested area was reduced to the two 5 mm thick tiles and tested at a flux of 3 MW/m^2 . After 10 cycles at this heat flux both tiles showed a substantial increase in surface temperature indicating that some type of tile delamination had occurred. Post-mortem analysis of the Be/Cu mock-up using scanning electron microscopy indicated that cracking had occurred in the beryllium tile with no evidence of cracking at the Be/Cu interface, Fig. 4(a). The crack initiation sites were associated with unmelted beryllium particles which were trapped within the plasma sprayed beryllium armor, Fig. 4(b). The cracks propagated along porosity striations which were present in the plasma spray beryllium armor. The porosity striations were uniformly spaced and seemed to be associated with the individual passes of the plasma spray torch during the build-up of the beryllium armor on the heat sink material. Lateral cracking in the beryllium tiles resulted in a decrease in the through thickness thermal conductivity resulting in the observed increase in the surface temperature.

3.3. High heat flux testing results: CuCrZr mock-up

The CuCrZr heat sink with the explosive bonded aluminum layer was tested at 1 MW/m^2 for 1400 cycles on all of the 5 and 10 mm beryllium tiles. The test had to be discontinued after 1400 cycles because of a water leak in one of the fittings which prevented additional cycling. No damage was seen on the mock-up except for a slight increase in the surface temperature on one of the sub-castellated beryllium 5 mm tiles. The temperature at the Be/Al interface was typically 250°C during thermal cycling. Peak surface temperatures of the beryllium tiles remained below 550°C . After repair of the water leak, testing was continued on the 5 mm thick beryllium tiles at a higher heat flux of 5 MW/m^2 . The mock-up survived 40 thermal fatigue cycles before the test was discontinued due to an increase in the surface temperature of the

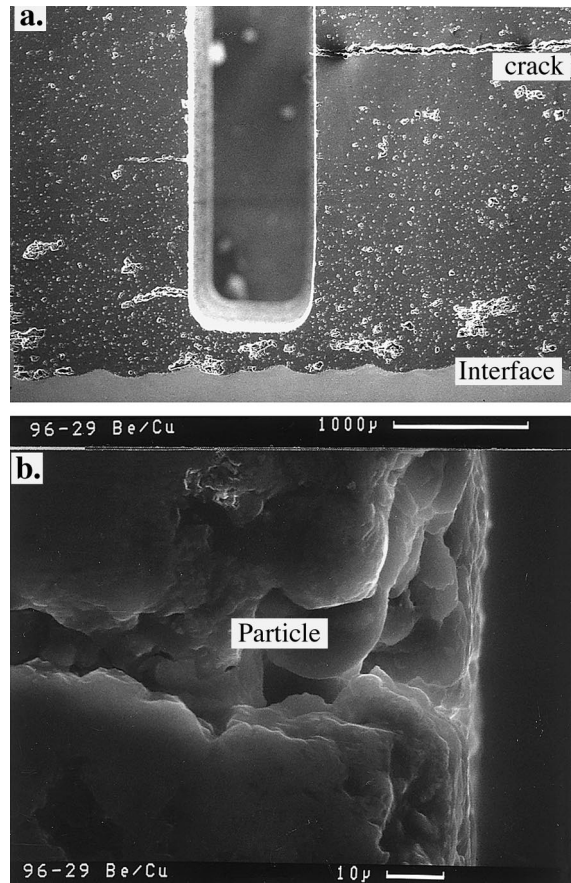

Fig. 4. (a) Cracks present in beryllium armor tile on the CuNiBe heat sink; (b) unmelted beryllium particles at crack initiation site in the beryllium armor tile.

individual beryllium tiles. Based on the results of the 5 MW/m^2 test, it is expected that the CuCrZr mock-up would have survived the 3000 thermal fatigue cycles at the lower heat flux conditions of 1 MW/m^2 . Post-mortem analysis of the Be/Cu mock-up using scanning electron microscopy indicated that crack initiation and propagation had also occurred in the beryllium armor tiles similar to what had been observed in the CuNiBe mock-up after high heat flux testing, Fig. 5(a). Crack initiation and propagation was also observed at sites where unmelted beryllium particles were entrained in the beryllium plasma sprayed armor, Fig. 5(b). Porosity striations were also present in the beryllium armor promoting lateral advancement of cracks and a decrease in the through thickness thermal conductivity.

4. Conclusion

Be/Cu mock-ups for high heat flux testing were successfully fabricated by vacuum plasma spraying thick

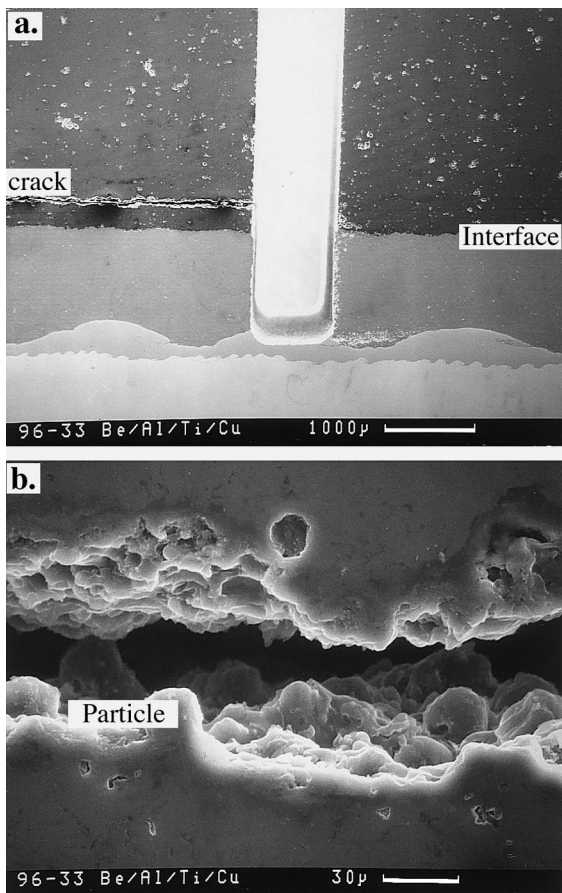

Fig. 5. (a) Cracking within the beryllium armor tile on the CuCrZr heat sink; (b) unmelted beryllium particles present along the crack.

beryllium armor (>15 mm) directly on heat sink materials of CuNiBe and CuCrZr with an explosive bonded layer of aluminum. High heat flux testing of the Be/Cu mock-ups, using ITER relevant conditions, were performed at the Plasma Materials Test Facility at Sandia National Laboratory using the 30 kW Electron Beam Test System (EBTS). The CuNiBe mock-up successfully survived 3000 thermal fatigue cycles at 1 MW/m² without damage. The CuCrZr mock-up successfully survived 1400 thermal cycles at 1 MW/m² without damage. The 1 MW/m² heat flux is four times the typical and twice the

expected design heat flux for the first wall modules in ITER. The Be/Cu mock-ups were also tested at 3 and 5 MW/m² until failure occurred which was indicated by an increase in surface temperature of the beryllium tiles. The Be/Cu mock-ups failed by lateral cracking in the beryllium armor tiles which reduced the through thickness thermal conductivity. Crack initiation sites were associated with unmelted beryllium particles which were present in the plasma sprayed beryllium armor. Unmelted beryllium particles can result from inefficient melting of the beryllium powder feed stock during the plasma spray process. Improving the process efficiency (i.e., beryllium powder size, operating parameters and torch to substrate translation) can minimize unmelted particles in the beryllium armor. Evidence of porosity striations were also present in the plasma sprayed armor which contributed to lateral crack advancement during the thermal fatigue test.

Acknowledgements

The authors would like to thank Brush Wellman Inc., for the machining and profiling of the beryllium plasma sprayed mock-ups and Don Butler from Northwest Technologies for providing the explosive bonded CuCrZr heat sinks. This work was sponsored by the DOE Office of Fusion Energy.

References

- [1] C.H. Cadden, B.C. Odegard Jr., Aluminum-assisted joining of beryllium to copper for fusion applications, Sandia National Laboratories Report SAND97-8445, January 1997.
- [2] J. Davis, ITER Materials Meeting, Garching Germany, 13–16 May 1996.
- [3] R.G. Castro, P.W. Stanek, K.E. Elliott, J.D. Cotton, R.D. Watson, *J. Nucl. Mater.* 226 (1995) 170.
- [4] R.G. Castro, P.W. Stanek, K.E. Elliott, D.L. Youchison, R.D. Watson, D.S. Walsh, *Phys. Scripta T64* (1996) 77.
- [5] D.L. Youchison, J.M. McDonald, L.S. Wold, High heat flux testing capabilities at Sandia National Laboratories, New Mexico, HTD-vol. 301, A.M. Khounsary (Ed.), *Heat Transfer in High Heat Flux Systems*, ASME Book No. G00956, 1994.